

Plasti-Fab Design Manual

Cold Storage Applications





PlastiSpan™ Insulation

Cold Storage Applications

Plasti-Fab PlastiSpan insulation board is ideal for use in wall and roof assemblies of cold storage facilities used for cooling and/or storing food, flowers and other commodities at temperatures ranging from normal room temperature 20°C (68°F) down to cryogenic temperatures -100°C (-148° F). As the service temperature decreases the quality and care required for construction becomes more critical.

PlastiSpan insulation board is well suited for cold storage facilities because it is dimensionally stable, provides excellent thermal resistance and is inert to a wide range of chemical. The closed cellular structure of PlastiSpan insulation board provides low water vapour permeance and low water absorption characteristics.

PlastiSpan insulation board is only one component in a construction. All components of construction as well as the

mechanical equipment for cooling and/or humidifying must act together to achieve a system that will enclose the cold storage space and hold it at the desired temperature for extended periods of time without deterioration. It is recommended that any lumber incorporated into the construction of a cold storage facility be pressure treated with wood preservative.

This brochure outlines the use of PlastiSpan insulation board in some common cooler and freezer applications. A discussion is also included on other components of the building, which may effect the successful construction, and operation of coolers or freezers. The table on the back cover of this brochure provides typical material properties for PlastiSpan insulation board.

General Principles

A low temperature area is constructed by properly enclosing the space and using refrigeration equipment to keep it at a low temperature by removing the heat. The size of refrigeration units and maintenance costs can be reduced and problems avoided by reducing as much as possible or eliminating the following sources of heat in the room.

1. Atmospheric or building heat moving through the floors, walls and roof. The thickness and type of insulation in the construction determines the rate of heat transfer
2. The method of operation of the room will dictate the frequency of door opening and the open interval. The door operation governs the heat gain in the cooled space to a far greater extent than the size of the door. Methods of operation that move material quickly through the door are beneficial.
Fork lift truck operation and other mechanical systems allow quick opening and closing of doors with mechanical or remote operators. Money spent on doors can relate directly to energy savings.
3. Vestibules outside of the cold room can also save substantially on the flow of warm air into a cold area. Vestibules usually have a simple door, which stops the flow of air until the main door closes. Provision should be made to load and unload cold rooms rapidly from access areas.

4. Infiltration of air from warm areas through process openings, unsealed openings around electrical conduit, structural members and equipment hangers, structural cracks and poorly constructed joints at the wall/ceiling line, construction joints, etc. Warm, moist air entering a freezer room is a particularly serious condition as it provides moisture that can lead to the rapid build up of ice, which can force movement of the structure
5. The operation of pumps, fans or lights in a low temperature space.
6. The movement of goods at higher temperatures than the cold storage room holding temperature. If quantities of produce are expected from transport vehicles at a higher temperature than the refrigerated area, the removal of this heat should be anticipated in the refrigeration unit design.
7. The automatic defrost cycle of refrigerating equipment.

Any modifications to the building design and operation or special care in workmanship that lowers heat gain to the cold room will reduce the load on the refrigeration equipment and, in turn, reduce energy costs. If sufficient reduction in heat gain can be assured at the design stage reductions in refrigeration equipment can also be realized.

Cold storage rooms should be constructed as large and high as possible. Heat loss occurs through the floor, walls and roof. The closer the building is to a cube, the less surface area and hence less heat gain there will be for a given volume. Increasing the storage room height is only practical within the limit of expected handling equipment, but with modern lift truck, ceiling heights of 7.5 to 9.0 m (25 to 30 feet) are not uncommon, and heights are seldom less than 6 m (20 feet). A larger cold storage area is enclosed with less proportionate wall area than a smaller area and the larger area will be cheaper to build and operate on the basis of unit volume of product stored.

It is important to provide for free circulation of refrigerated air from the refrigeration unit. Normally, at least 0.9 m (3 feet) clear height is provided above stored goods for circulation. Distribution ducts, fans and adjustable louvers should be carefully placed to provide for uniform distribution of cold air throughout the low temperature space.

Baffles should be used to direct refrigerated or warm air from equipment motors, away from insulated surfaces that are close to the refrigeration equipment. Since moving air will remove some moisture from stored produce, arrangements may be required to minimize the weight loss from bulk stored goods.

Air seals and vapour barriers can be crucial in the construction of cold storage rooms. The construction must be accomplished so that no air can move through the construction from the outside to the inside of the room. The movement of water vapour must be restricted by the use of vapour barriers or by the vapour barrier characteristics of the PlastiSpan insulation board. (See Vapour Barrier section, page 3).

All sub-trades on the site should be aware of cold storage construction principles. Conventional attachment of equipment hangers or normal installation of mechanical or electric equipment can create air or vapour leaks through the sealed construction that will contribute to the early failure of the construction.

Types of Service

Low temperature space can be divided into a number of classifications based on the service conditions. The construction of the space depends to a large extent upon the service conditions.

Coolers – Above 0°C (32°F)

- a) Dry Coolers – storage of dairy products, fruit and vegetables particularly holding food for use close to kitchens, sales areas, etc.
- b) Wet Coolers - storage of vegetables over a long term can be achieved by maintaining very high humidity to prevent shrinkage of the vegetables. It is important to avoid condensation since free water will promote decay. Wet coolers may contain complex humidifying equipment to achieve maximum storage life. Because of the sensitivity to condensation, it is important to avoid thermal shorts and to maintain a full uniform thickness of insulation in the construction. Adequate air circulation becomes much more important at high humidity to avoid condensation. These coolers may require both cooling and heating equipment when constructed in Canada particularly if they are constructed as free standing buildings.

Vapour barriers are not necessary in either wet or dry coolers when PlastiSpan insulation board is used as the sole insulation. Air leakage through the construction must be minimized by the use of air barriers and sealing compounds at all openings or voids.

Coolers – Below freezing to –2°C (28°F)

The holding temperature for meat has been established as -2C (28F). Since this holding temperature is below the freezing point of water, extra care is needed in construction in order to destructively avoid ice build-up in the building system.

For space maintained below freezing, design considerations relating to the air seal at the wall to roof juncture as well as requirements for sealing around openings, such as structural members and electrical conduit that penetrate into the insulated space, become important. A separate vapour barrier is not necessary in this construction but an adequate air seal is essential.

Freezers at constant temperature of –23 to –33°C (–9° to 29°F)

This service temperature range applied to most commercial frozen food storage. Maintaining a constant low temperature in a space creates a constant thermal gradient through the building section. This can cause rapid deterioration of low temperature space unless careful attention is paid to the construction techniques. Vapour barriers are required in freezers either as a membrane, a coating or by the use of thick sections of PlastiSpan insulation board combined with primers and adhesives to achieve a vapour barrier rating in the construction (see Vapour Barrier section).

It is important that an adequate air seal and vapour barrier be maintained at wall-ceiling junctures and around all penetrations into the low temperature space.

Sharp Freezers - Cycle from Room Temperature Down to –40°C (–40°F)

These freezers are generally small rooms with oversized refrigeration equipment so that a product can be taken from room or processing temperature down to a holding freezer temperature in a short period of time. Sharp freezers reduce the cooling load on the holding freezer and improve product quality by a fast freezing action. Because sharp freezer space is alternately warm and cold, in addition to the thermal loads imposed on normal freezers there also concerns related to

expansion and contraction, condensation, freeze-thaw, air “blast” pressure, etc.

Sharp freezing is often done in an area where conveying equipment is used to move product through an area with very high capacity refrigeration equipment. A sharp freezer area is a very severe service area particularly with respect to the surface finish. Because of the warm and cold cycles, drainage may be necessary to draw off condensed moisture to keep the construction dry. Thermal expansion and contraction may require mechanical fastening of insulation and surface finishes. A high performance vapour barrier membrane or coating is mandatory when constructing sharp freezers. Construction should be well thought out and provisions made for easy maintenance and replacement of components.

Cryogenic Service - Below -100°C (-150°F)

This extreme low temperature service is not as common as the service required for the food industry. Cryogenic service is generally encountered in scientific work or in the industrial storage of liquefied gases. Very low temperatures increase the severity of the service and the possibility of deterioration.

For continuous cryogenic service, a very high standard of workmanship is required. Adequate provision must be made for a high-grade vapour barrier to assure the elimination of water vapour or air movement through the construction. It is mandatory that an adequate insulation thickness be used to provide continuous thermal protection around the cryogenic space with no penetration of structural, electrical, or other members. It is recommended that any lumber incorporated into cold storage construction be pressure treated with wood preservative.

Design Notes

PlastiSpan insulation board for cold storage construction is normally applied in 2 layers with joints tightly butted together and staggered between layers. Single layer insulation is used only in dry coolers where the service is not as demanding.

PlastiSpan insulation boards must be firmly and permanently bonded to the substrate (eg. wall, ceiling or roof) or second layer of insulation. Generally, thick coatings of heavy-bodied adhesives are used to provide some bridging of any irregularities in the substrate. Adhesives are applied to provide approximately 100% contact and to fill any voids. Spot or strip applications of adhesives are used only where a vapour or air barrier is installed. For floor applications, the first insulation layer is generally bonded to the sub-slab but the second layer is laid dry.

Where small low temperature rooms are constructed, the pressure created by slamming the door of a tightly sealed room can be destructive. Specify doors with a built in pressure relief vent or provide a separate vent through the wall to relieve pressure.

Where a fire sprinkler system is constructed inside a low temperature area, it should be of the dry sprinkler type.

Floor drains should not be installed in freezers but may be required in coolers. Where refrigeration units require drain lines, the drain pan and drain line must be insulated and preferably heat traced. The drain line should be installed with a steep slope.

Penetrations of the insulated closure such as pipes, conduit, hangers, etc. must be insulated a minimum of 400 mm (16”) on the warm side with an insulation thickness the same as that penetrated.

PlastiSpan insulation board is normally used in the walls and ceilings or roofs of low temperature space. PlastiSpan HD insulation board would normally be used for floors, but the thickness and reinforcing of the wearing slab will dictate the required insulation compressive strength.

Where a roof membrane is to be placed over PlastiSpan insulation board, follow the specification in the appropriate PlastiSpan “Building Insulation Roof Applications” brochures.

Recommended Insulation Thickness

Thicknesses for low temperature insulation are calculated on the basis of 7.88 W/m^2 ($2.5 \text{ BTU/ft}^2/\text{hour}$) heat gain through the walls, roof and floors. On this basis, and considering the insulation provides the total thermal resistance of the wall, the thicknesses shown in the tables below are recommended for room service temperature range noted:

Where cold rooms are adjacent to process areas, machine or boiler rooms, or where sun loads are expected on south or west walls or buildings, the thicknesses recommended above should be increased. Low temperature rooms built beside other low temperature rooms may require less insulation but consideration should be given to the possibility of a shut down in either low temperature room and its effect on the adjacent room.

Service Temperature and Recommended Insulation Thickness

SI VALUES				IMPERIAL VALUES			
PLASTISPAN		PLASTISPAN HD		PLASTISPAN		PLASTISPAN HD	
Temp° C	Thickness	Temp° C	Thickness	Temp° F	Thickness	Temp° F	Thickness
16 to 12	50 mm	16 to 11	50 mm	61 to 52	2"	60 to 50	2"
11 to 6	75 mm	10 to 5	75 mm	51 to 42	3"	49 to 40	3"
6 to 1	100 mm	4 to 0	100 mm	41 to 33	4"	39 to 30	4"
0 to -4	125 mm	-1 to -6	125 mm	32 to 24	5"	29 to 20	5"
-5 to -9	150 mm	-7 to -11	150 mm	23 to 14	6"	19 to 10	6"
-10 to -14	175 mm	-12 to -17	175 mm	13 to 5	7"	9 to 0	7"
-15 to -19	200 mm	-18 to -22	200 mm	4 to -4	8"	-1 to -10	8"
-19 to -24	225 mm	-23 to -28	225 mm	-5 to -14	9"	-11 to -20	9"
-25 to -29	250 mm	-29 to -33	250 mm	-15 to -23	10"	-21 to -30	10"

Vapour Barriers and Air Seals

When moisture accumulates in a building assembly, it decreases the thermal efficiency of the insulation component. Moisture can accumulate in a building assembly as a result of temperature/vapour pressure differences from one side of the building assembly to the other. Air at a higher temperature enters the building assembly through gaps in the construction and water vapour condenses within the materials used for wall, ceiling or roof construction.

Infiltration of moist air is minimized in low temperature rooms by:

- a) Staggering joints in insulation between layers.
- b) Sealing joints and around all penetrations in the construction that would allow air movement into the cold room (such as conduit, piping, hangers, etc.)
- c) Applying a sheet membrane at the wall to ceiling (roof) juncture

The transmission of water vapour through the construction can be controlled by several methods:

- a) Placing an impermeable membrane (vapour barrier) on the warm side (outside) of the insulation. This vapour barrier can be in the form of a sheet membrane or a coating. The barrier must be maintained around nails or other fastening and around any penetrations through the vapour barriers such as electric conduit, piping, etc. Membranes must be sealed at the joints with vapour barrier mastic or lapped and fastened to maintain the barrier. Coatings should be applied in 2 coats to eliminate any imperfections in the coatings.

A vapour barrier material in construction is defined as a product meeting CAN/CGSB-51.33-M or CAN/CGSB-51.34-M. Additional information on vapour barrier requirements for commercial applications can be found in Part 5 of the National Building Code (NBC) of Canada. Cold storage space is a severe service for vapour barrier systems and authorities ask for better vapour barrier materials. The severity of the service increases as the rooms are held at colder temperatures and the outside air temperature and humidity increase. For freezer applications a water vapour material with a lower permeability of less than $15 \text{ ng/Pa} \cdot \text{s} \cdot \text{m}^2$ (0.25 perms) is recommended.

- b) Construct a wall using a combination of materials that will provide a total water vapour permeability low enough so that moisture entering the room can easily be removed during the defrost cycle of the refrigeration unit. This is known as the flow-through-principle of cold storage construction and is adaptable to construction with PlastiSpan insulation board. The water vapour permeability value of PlastiSpan insulation board decreases with increases in thickness. In cold storage facilities, when the water vapour permeability of PlastiSpan insulation board is combined with that of the primers and a low permeability adhesive, the total permeability of the system approaches that of a vapour barrier. It is not necessary to reach the value of 0.25 perms in the construction as long as the permeability of the individual components of the wall increase

in permeability from the warm to the cold side of the wall.

See Canadian Building Digest 57 by the Division of Building Research, National Research Council for more information on this type of design. A Plasti-Fab representative can supply an analysis of permeability of a building section should you require it.

- c) In Canada, it is possible for a cooler room to be a cold room part of the time (summer) and a heated room (i.e., warmer than the outside air) for part of the time (winter). The requirement for vapour barriers in these rooms is not as critical where PlastiSpan insulation board is used providing seals are provided against air filtration. Control of water vapour movement within the normal definition of a vapour barrier at less than $60 \text{ ng/Pa} \cdot \text{s} \cdot \text{m}^2$ (1 perm) has proven adequate.
- d) Where an impermeable finish (such as metal) is used as a finish in a cold storage room, an impermeable barrier is also required on the warm side (outside of the insulation) to preserve the efficiency of the insulation.
- e) It is important that the roof system includes an effective vapour and air barrier. In many roofs, the roof membrane will act as this barrier but the membrane characteristics should be carefully checked.

Site Design

Special construction is necessary to keep soil under large freezers from freezing and heaving the floor (see below). Soils susceptible to frost heaving should be avoided under freezers. The site should be well drained with the ground sloped away from the building in all directions. The exterior grade should be finished a minimum of 200 mm (8") below the floor level.

Floor Design

Most cold storage buildings are built using slab on grade. Use 300 to 450 mm (12 to 18") of granular fill underneath a slab on grade. Place a slip sheet of no.15 saturated felt between the wearing slab and the wall insulation and at floor expansion joints, prior to pouring the slab. A slip sheet may be placed over the entire surface of the floor insulation under the floor slab at the option of the designer.

Where the cold storage room incorporates an above grade structural floor, the only concern is to provide sufficient insulation thickness to reduce heat gain from the space below the floor.

Cooler Floors

Floors can be laid directly on the granular fill without insulation except that perimeter insulation should be carried down the foundation wall or under the floor slab a minimum of 1.2 m (4 feet). The perimeter insulation thickness should equal the thickness of the wall insulation.

Freezer Floors

Freezer floors usually consist of a reinforced concrete structural sub-slab, a layer of insulation followed by a reinforced concrete wearing slab. The floor insulation is installed in two layers with a total thickness equal to that of the wall insulation. Where the smallest dimension of a freezer floor (length or width) exceeds 4.88 m (16 ft), provision must be made to heat the underside of the sub-slab so the sub-grade will not freeze and heave the floor or the foundation. Heating can be provided using electric cable or a pipe grid circulating heated anti-freeze or brine. The cable or pipe can be located in either the sub-slab or the soil below the slab. In all cases, permanent thermocouples should be installed in the soil under the slab in several locations to monitor the soil temperature. When the soil temperature drops below freezing the heating devices can be turned on. Control of the heating device by thermostat is also possible. Heating devices may not be required when constructing a floor slab over bedrock or deep, well-drained sand.

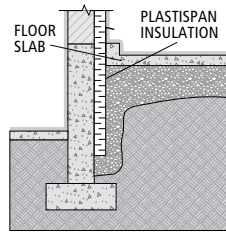

Vertical Insulation

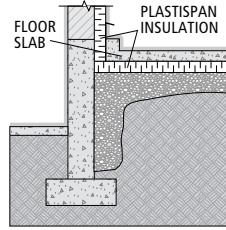

Horizontal Insulation

The top wearing slab should be constructed with a minimum number of construction joints. Where lift trucks operate across construction joints they need to be specially reinforced to prevent slab movement as lift trucks cross the joint. Install slip rods across the joint during construction or provide a tongue and groove joint.

A 5% deflection in a concrete slab is accepted as the maximum allowable to avoid cracking. The wearing slab can be reinforced to allow heavier point loads to be distributed over the insulation. The insulation should be chosen to allow for the expected live and dead loads plus an adequate margin of safety.

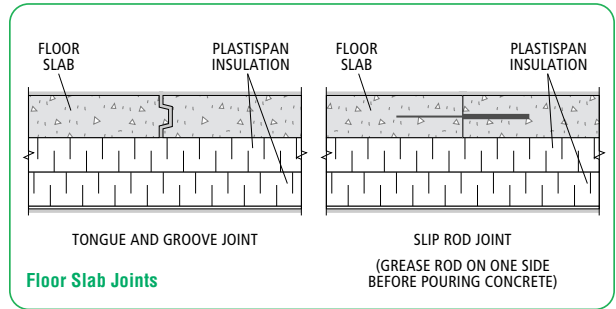

Wall Design

The insulation layer should be maintained continuously over the entire surface of the wall. If pipe, conduit, structural steel, etc. penetrations are necessary, they should be insulated a minimum of 600 mm (2 feet) along the length of their penetration into the warm room with insulation thickness equal to the wall insulation.

A hollow concrete block wall should be avoided between a cooler and a freezer. The voids in the blocks may accumulate moisture, which will freeze at the bottom of the wall cracking the block and leading to wall failure. Use solid walls (no voids) or insulated panels where these walls are necessary.

Where walls are between low temperature rooms, it is only necessary to insulate the walls to look after any differential temperatures between the rooms. Often, these walls are the result of additions being constructed and the wall projects through to the exterior of the building or to adjacent warm space. Perimeter insulation is required 1.2 m (4 feet) into the room at all edges where the wall is exposed to a warm area.

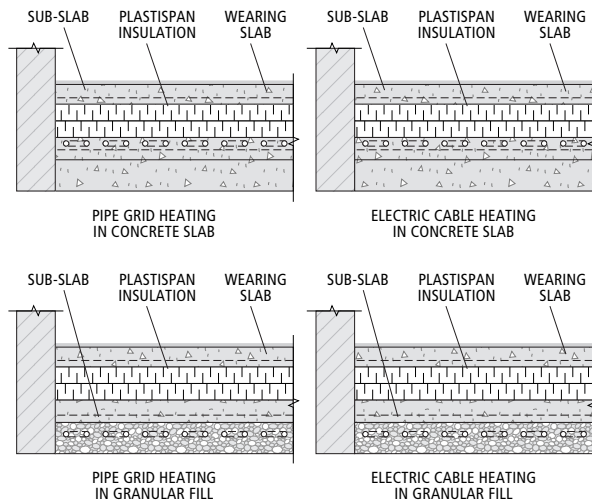

Under Slab Heating

It is possible to eliminate the sub-slab but great caution is suggested when considering this step. The subsoil should not be susceptible to frost heaving, a good depth of granular fill should be used and excellent drainage provided. The insulation should be sealed from ground moisture by a 6-mil polyethylene or other high performance vapour barrier membrane.

Before eliminating the sub-slab, consideration should also be given to construction conditions. The sub-slab provides a working slab, which makes it possible to provide a higher standard of workmanship, which is important in this construction.

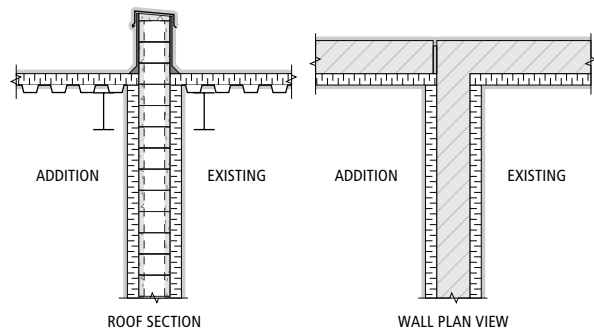

Wall Structure – Add on cold rooms

In large units the structural frame of the low temperature room can be placed inside the room and the walls constructed outside the frame to allow the insulation to run past the columns. The structural frame is held at the constant room temperature and the walls are easily insulated. The walls should be tied to the columns at intervals. The ties do not provide a significant thermal short but should be embedded into mastic for their complete penetration through the insulation as an air and vapour seal.

Walls should be protected from stored goods by placing a curb at the floor line to prevent piled goods from touching the wall. The curb also provides an air space for the circulation of air.

Substantial door bucks well anchored to the structural frame should be incorporated into the construction especially where mechanically operated doors are required due to lift truck operation.

Light coloured finish on the exterior walls reduces the sun load on the building.

Ceiling Design

Where a cold storage room is incorporated into a larger building an insulated ceiling in the cold storage room separate from the roof of the building is recommended. The ceiling is constructed solely for the purpose of closing in and insulating the cold storage room.

Ceilings should be suspended from the roof with a ventilated air space between the insulated ceiling and the roof. This space should be ventilated with air from within the building. High humidity outside air is not suitable for ventilating.

The joint at the wall-ceiling juncture must be constructed and sealed properly (see Vapour Barrier section). This is a common point of failure in cold storage rooms as the juncture can open up due to building movement and allow moist exterior air into the cold room.

Support cooling ducts, racks, etc. from the floor so as not to create thermal shorts through the ceiling. If hangers penetrate ceiling insulation, insulate rods at least 400 mm (16") above the ceiling insulation and seal around hanger rods with mastic sealer.

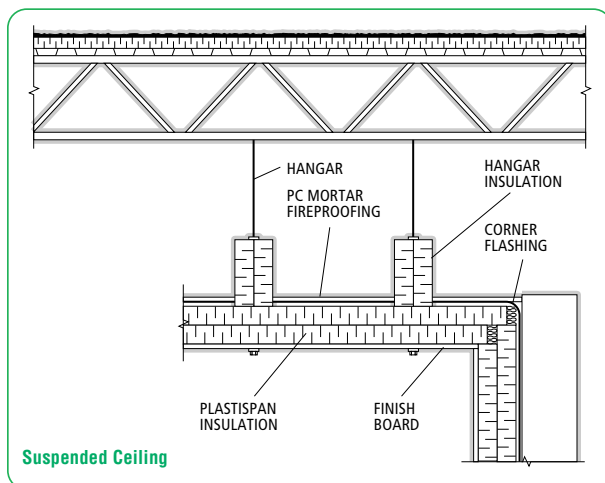

Roof Design

Although suspended ceilings independent of the roof structure are a better design in cold storage rooms, the savings to be made by placing the cold storage room insulation over the roof deck are often too great to overlook. Large roof areas of buildings designed solely for low temperature storage show great savings by using an insulated roof construction. The insulation should be well bonded or mechanically fastened to roof deck to provide a good base for the roof membrane.

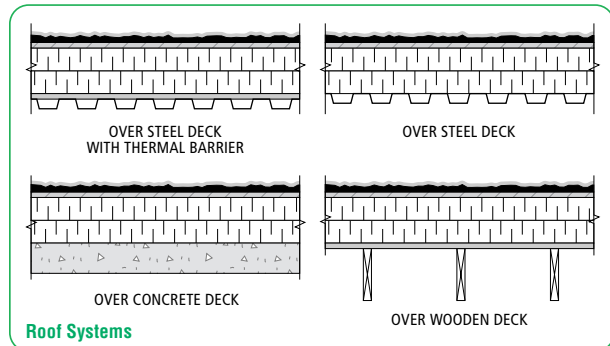

With the roof and cold storage insulation combined into a single construction, leaks become more difficult to find and the effects of leaks are more serious. Adequate control joints should be provided in the roof membrane. It is important that the air seal and the vapour barrier of the wall are carried over to the roof membrane to maintain a seal and barrier for the life of the building (see details on wall to roof junctures).

Where steel roof decks are used, a fire rated roof deck assembly may be required. The addition of 12.7 mm (1/2") gypsum board between the steel roof deck and the PlastiSpan insulation board is usually acceptable to the code or insurance authorities.

The roof should be designed to be well drained. A slope of 2%, or 1/4" to the foot, is recommended. For freezers, runoff must be carried off the roof at the edges with gutters and downspouts since a drain through the cold storage area would freeze. Arrangements should be made to drain the water off the site to avoid foundation problems.

The sun load on the roof can be reduced by the use of a light coloured membrane or gravel.

Freezer & Cooler Doors

In-fitting doors can be used in coolers and in freezers down to -18° C (0° F). These doors are satisfactory in coolers down to 0° C (32° F) with double seal gaskets.

In freezers where there is a possibility of the door freezing shut, the door should be fitted with a single seal gasket and thermostatically controlled electric heating cables, for service down to -17 C (0° F).

Overlapping doors are recommended where freezers operate below -18° C (0° F). These doors should be equipped with heating cables where there is any possibility of the door freezing fast.

Application

This section outlines the general requirements as well as the primers, adhesives and fasteners that are recommended for the application of PlastiSpan insulation board in cold storage construction. Various wall, roof/ceiling and floor construction are detailed, and can be chosen according to the requirements of the building.

Each construction starts with a preparation subsection to indicate any special preparations required prior to the application of the insulation. Finishes over the insulation are common to all types of construction and the finish subsection follows at the end of the section.

General Requirements

Insulation should be installed when temperatures are over 4°C (40°F) where adhesives or coating are to be applied. If the temperature is under 4°C (40°F), temporary heat is required in the building. Use hoarding and temporary heat outside the building enclosure to keep wall surface temperature above -5°C (20°F).

Do not leave PlastiSpan insulation board exposed to direct sunlight for periods longer than one week. If prolonged exposure is expected, insulation is to be factory wrapped in bundles using opaque, white polyethylene. If the surface of insulation becomes degraded, brush down with a corn broom until original colour is restored.

Do not use solvent base adhesives or mastics, unless the manufacturer specifically recommends their use with PlastiSpan insulation board.

PlastiSpan insulation board size is generally 0.6 x 1.2 m (2 ft. x 4 ft.) for low temperature applications. However, 0.6 m x 2.4 m (2 ft. x 8 ft.) PlastiSpan insulation boards are used for mechanically fastened systems.

Primers, Adhesives and Fasteners

A variety of primers and adhesives may be used. Descriptions, detailed application instructions, mixes, etc. are presented here to allow the adhesives to be mentioned

without detailed instruction in the description of the construction.

Primers

These are used as a wall treatment to ensure a better surface bond with adhesives than would be provided by an unprimed wall. In low temperature construction the primer may also be used to provide all or part of the vapour barrier coating. In this case, the primer must be carefully verified to assure that it has the required low water vapour permeability. Primers (particularly solvent base types) must be dry prior to the application of the insulation.

Hot Asphalt Adhesive

Hot asphalt (CSA Spec. A 123 3 Type 2) with a softening point of 77°C (170°F) is used. An unbroken coating of hot asphalt can provide a vapour barrier. As a heat sensitive product, the bond can lessen at elevated temperatures. At extremely low temperatures, asphalt becomes brittle and may fracture. Application requires experience, as the asphalt must contact the substrate while it is still fully liquid. Application of the hot asphalt is made with a roller coater. Maintain asphalt temperature at no higher than 177°C (350°F).

Before installation commences, walls should be dry and warm. In cold weather, the walls should be carefully examined to be sure there is not a thin film of frost on the wall.

A double coat method of application is recommended. The wall is primed with a high solids primer to leave a film of asphalt on the substrate so the hot asphalt contacting the substrate can melt the primer film.

Use of Roller Coater

Roll PlastiSpan insulation board over moving roller pressing into contact with roller in direction of roller rotation and at same speed. Before applying the first layer of PlastiSpan insulation board run the top of the insulation board over the roller coater and immediately apply a layer of asphalt on the entire board. Let harden,

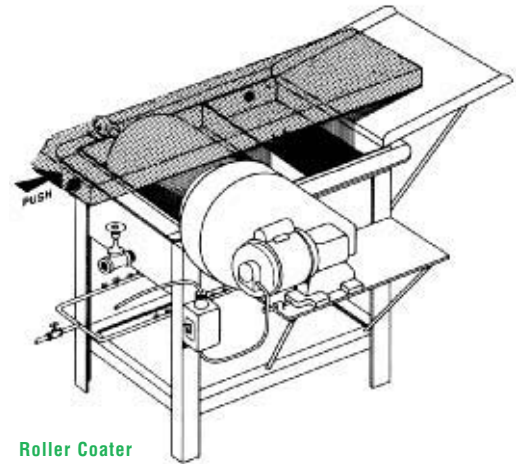

Roller Coater

turn board over and apply asphalt to the other side with roller coater and immediately apply the board to primed wall before the asphalt can cool. When the second layer of insulation is applied run the PlastiSpan insulation board over the roller coater and immediately place firmly against the asphalt coating on the first layer.

The bond obtained with hot asphalt is completely dependent on workmanship. Experienced workmen must be employed when this adhesive is used.

Portland Cement Mortar

A regular portland cement mortar or one modified with latex additive can be used as an adhesive. Ask the Plasti-Fab Ltd. representative for information on the uses of the adhesives for wall construction.

Fasteners

Nails – Use common galvanized or galvanized box nails with 25 mm (1") prepunched fibre washers.

OR

Galvanized insulation nails with 12 mm (1/2") diameter head.

Wood Skewers – Use 6 mm (1/4") diameter hardwood skewers treated with a wood preservative. Skewers are used to provide a mechanical fastening between two layers. Skewer length should equal both thicknesses of insulation. Skewers should be driven in at an angle of 30° from perpendicular to face of insulation. 12 skewers/m² (1/ft²) for walls and roofs and 24 skewers/m² (2/ft²) for ceilings.

Application

U-Drive Fasteners – To fasten a nailer, strap, or bracket into a concrete or masonry wall. A carbide bit is provided with the fasteners to drill a pilot hole into the substrate. The U-Drive fastener is hammered through the nailer or bracket and the insulation into the pilot hole. Minimum penetration of 25 mm (1") is recommended.

Vapour Barrier and Air Seals

Trowel - On

Prime wall if recommended by coating manufacturer. Trowel suitable coating onto wall/ceiling to a minimum of 3 mm (1/8") thickness after drying. Two-coat application over rough surfaces will tend to eliminate penetrations in film.

Film Vapour Barrier

Prime and brush asphalt emulsion adhesive onto masonry or concrete wall.

While still tacky roll in film vapour barrier working out air bubbles as work proceeds. Edges to be lapped 75 mm (3") and sealed with asphalt emulsion or sealing tape. Staple or nail onto suitable surface.

The air seal is assured by using a flexible flashing at wall corners, walls/ceiling, or wall/roof joints. A mastic sealer is required around any penetration of the air barrier such as pipes, electrical conduit or hangers. All adhesives and sealers are to be solvent free and compatible for use with expanded polystyrene insulation.

Walls – Concrete or Poured Concrete

Wall construction will be carried out in the normal manner.

Preparation

Prior to application of the insulation the walls should be prepared as follows (where applicable):

Walls should be clean, dry, straight and smooth without fins or projections.

Concrete surfaces must be free of form release oils or other agents.

Mortar joints cut flush with masonry.

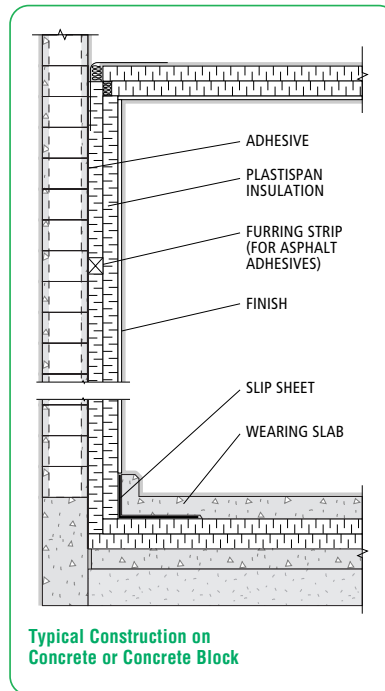

Typical Construction on Concrete or Concrete Block

Where necessary, back plaster walls with Portland Cement Mortar to straighten.

Where asphalt is used as an adhesive, or where film vapour barriers are used; install a horizontal furring strip on the wall over the film vapour barrier if used at 2.4 m (8 ft.) centres or less using anchor bolts. Seal around anchor bolts with vapour barrier sealer before tightening.

Construction

Prime walls with two coats of asphalt primer and allow to dry completely.

Apply vapour barrier.

Lay first row of insulation to a level line marked around room.

Asphalt Adhesive

Apply PlastiSpan insulation board with hot asphalt adhesive using a roller coater. When the second layer of insulation is placed immediately drive wood skewers through both layers of insulation.

Plasti-Fab General Purpose Adhesive

Apply PlastiSpan insulation board with Plasti-Fab General Purpose Adhesive for each layer.

Mechanical Fastenings

Apply PlastiSpan insulation board with long edges routed for 19 x 89 mm (1" x 4") nailer. Lay nailer into routed groove and to substrate using U-Drive fastener, one fastener for each 600 mm (24").

Apply second layer of PlastiSpan with long edges routed at right angles to first layer using galvanized nails to fasten second layer nailer to each first layer nailer.

Construct wall - ceiling/roof juncture according to detail selected below.

Walls – Ceiling Junctions

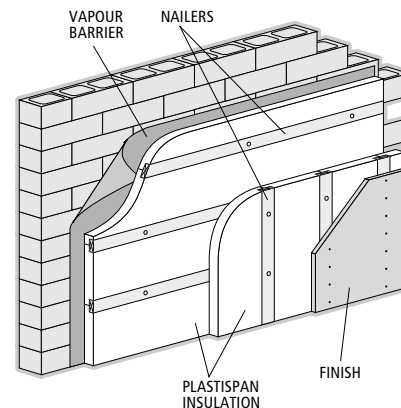

Type 'A'

This juncture incorporates a heavy flashing as an air and vapour barrier with the construction designed to be flexible and to preserve the flashing.

Before wall insulation is completed, bond corner flashing to wall using rubber asphalt emulsion applied with brush, spray, or roller? Position flashing [minimum 0.9 m (36") wide] so half the width is bonded to the wall and half to the roof or ceiling. Seal laps in flashing with rubber asphalt adhesive.

As wall insulation and roof insulation are laid, pack glass fibre insulation into joint.

Bond flashing on warm side of roofing insulation with rubber asphalt emulsion compressing the glass fibre moderately at corner.

Application

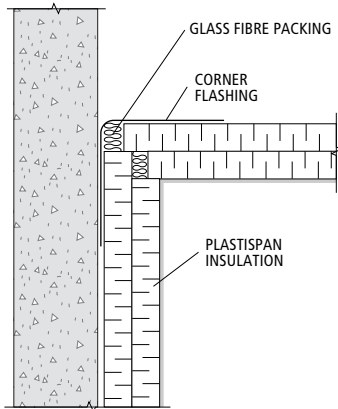

Type 'B'

This juncture is designed to be rigid. Any movement that occurs will be taken up by the flexibility of the foam several feet back from the corner.

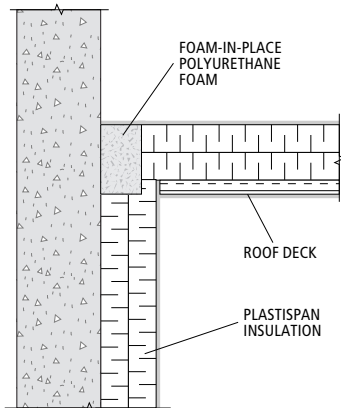

Bring wall insulation up wall until it is level with the roof insulation or until it butts the roof deck or suspended ceiling. Bring roof insulation over the wall insulation so that the interface is closed but at least 50% of the second layer is exposed in the void.

Fill void between wall and insulation with foam-in-place polyurethane foam. When surface of the polyurethane foam is no longer tacky, it can be rolled down to provide a surface flush with the rigid insulation.

Walls – Wood Frame

This type of construction is used on smaller buildings or to enclose a room inside a larger structure. There is no fire rating to this construction and it is not recommended for larger buildings. If the room is to maintain high humidity, condensation may occur at the studs.

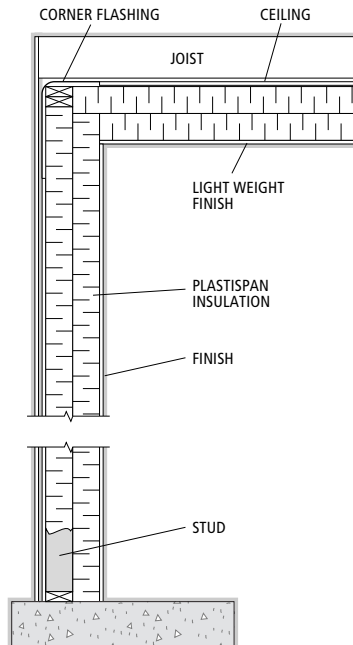

Preparation

Erect 38 x 89 mm (2" x 4") or 38 x 140 mm (2" x 6") stud wall on foundation that extends below frost line, or on floor of existing building.

Construction

Install film vapour barrier on the outside of stud wall sealing all joints and sealing to the plate at the floor line.

Install wall ceiling flashing at top plate sealing to vapour barrier at the top plate. Drape flashing over plate. Cover vapour barrier with exterior sheathing extending above top plate the depth of the ceiling joist.

Apply exterior finish.

Fill space between studs completely with insulation [use 89 mm (3 1/2") thick or 140 mm (5 1/2") thick insulation].

Apply second layer of insulation horizontally to studs on interior of the wall, nailing in place to make up total thickness of insulation required.

Nail finish plywood or other nailable finish through insulation into stud using a galvanized nail.

Ceilings – Under Concrete Slab

Where poured concrete walls and ceilings are to be insulated, corner flashings are not necessary because there is little chance of building movement or air leakage at the junctures.

Preparation

Concrete ceilings to be clean, dry, straight and smooth without projection or fins. Where necessary straighten ceiling by back plastering with Portland cement mortar.

Concrete surfaces to be free of form release oils or other agents.

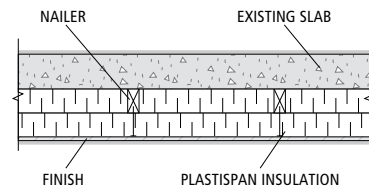

Construction

Prime ceiling with 2 coats of primer if required. Install film vapour barrier if required. Apply first layer of insulation by mounting furring strips the same thickness as the first layer of insulation using U-Drive Fasteners or anchor bolts. Nailers to be placed at 600 mm (2'- 0") face to face spacing and insulation placed between nailers using adhesive of choice and toe nail to hold in place.

Apply second layer using adhesive and then nail through to nailer using insulation nails or nails with 25 mm (1") washers.

Use lightweight finish over insulation or use nailable finish fastened through to nailers.

Application

Ceilings – Wood Frame

Smaller buildings and cold rooms inside buildings are likely to be of wood frame construction.

Preparation

Erect ceiling joists over stud wall in usual manner. Take care with spacing so that precut insulation will fit in joist spaces.

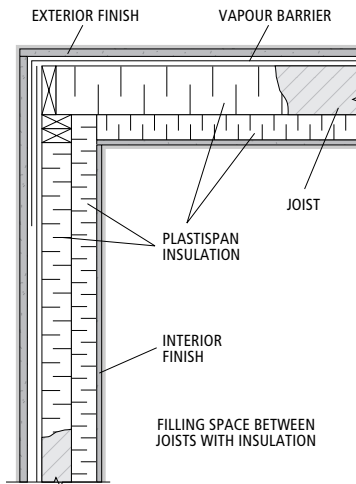

Construction

Place inside layer of insulation under ceiling joists and nail into joist.

Nailable finish is nailed through insulation into ceiling joists.

From outside the structure completely fill the space between the joists with precut insulation board. Install film vapour barrier over top of the ceiling joists. Bring film down on the outside of the wall past the header joist and seal to wall film vapour barrier.

Nail exterior finish over ceiling joists.

Roofs – Steel, Concrete, or Wood Decks

Preparation

Where top of wall is flush with roof, install wall header and fascia. Set fascia to level of top of insulation.

Construction

For roof construction and type of membrane selected see the following Plasti-Fab Roof Insulation brochures:

- Selection, Application and Specification
- Built Up Roofing
- Fire Rated Roof Assemblies
- Single Ply Roofing
- Sloped Roof Insulation
- Standing Seam Roofing

Complete construction of wall-ceiling juncture by bringing flashing over onto insulation and adhering it to the insulation with hot asphalt or an adhesive recommended by flashing and membrane manufacturer.

Apply roof membrane.

Concrete Floor – Over Fill

Preparation

Provide adequate depth of well drained granular fill. Install heating equipment in subgrade if necessary. Provide a concrete sub floor a minimum of 75 mm (3") thick with a wood float finish.

Prime floor.

If a sub floor is not used, place a minimum of 6 mil polyethylene over sub grade.

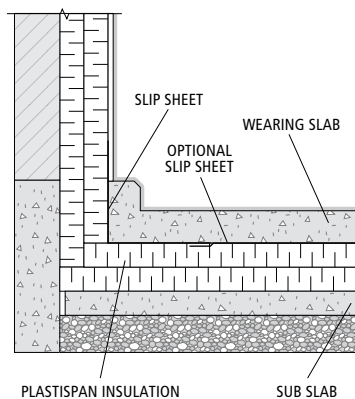

Construction

Mop floor with hot asphalt and lay first layer of insulation while asphalt is still liquid. Lay second layer of insulation dry over first layer and skewer where necessary to hold in place. Around edge of

floor where it meets the wall, place slip sheet (No. 15 asphalt saturated felt) so 450 mm (18") of felt is on the floor insulation and 450 mm (18") is against the wall insulation. Bond slip sheet to wall with spot application of rubber asphalt adhesive, filled asphalt emulsion or Plasti-Fab General Purpose Adhesive.

Lay slip sheet over floor insulation if required.

Pour concrete floor over insulation.

Wooden Floor – Over Existing Uninsulated Floor

Used in smaller walk in rooms where it would be inconvenient to pour a concrete floor or where a small low temperature room is constructed in an existing building. Use existing floor as sub floor.

A ramp may be required at door because of the raised floor in low temperature space.

Construction

Lay 6 mil polyethylene vapour barrier over existing floor and seal to wall vapour barrier.

Lay insulation in two layers without adhesive over vapour barrier with tight joints.

Lay 19 mm (3/4") plywood over insulation.

Leave space between wall and floor for expansion.

Lay a second layer of 19 mm (3/4") plywood over first layer after placing a bead of construction adhesive on 300 mm (1 foot) centres. Stagger joints.

Nail two layers of plywood together.

Apply floor finish (lino, tile, etc.).

Finishes Over Insulation

PlastiSpan insulation board should be covered with a non-combustible finish in order to meet the requirement of the Building Codes.

Application

Walls

The finish in a cold storage area will depend on the service. Finishes such as FRP, FRP finished plywood, metal, plywood - finished or unfinished may be required. Joints may also need to be sealed for sanitary purposes and suitable moulding are available. Install in accordance with finish manufacturer instructions.

Nailable finishes are to be supported by the nailers embedded in the insulation.

Ceilings

The weight of the ceiling finish must be considered during construction. Double the fasteners required for a wall finish if finish manufacturer does not specify attachment.

A preferred finish is lightweight latex cement finishes such as Flintguard 150-03. This finish is light enough that it can be applied to surface without tying back to the suspension system to carry the weight of the finish.

Placing Room in Service

A low temperature room must be brought down to service temperature slowly after construction to avoid damage.

As room is brought down to temperature, mechanical equipment should be checked and adjusted to provide uniform temperature throughout space.

Specifications

Part 1 – General (See Note 1)

Related Work Specified Elsewhere
(See Note 2)

Qualifications

Insulation shall be installed by mechanics skilled in this work in strict accordance with manufacturer's printed instructions.

Submittals

Submit samples and manufacturer's literature for approval before ordering materials and proceeding with the work.

Delivery, Storage and Handling

Deliver and store materials undamaged in original taped bundles.

Protect PlastiSpan insulation from prolonged exposure and sunlight (over four summer days) Store under light coloured tarpaulins. If surface becomes yellow and degraded, broom surface back to original colour.

Store roofing materials subject to damage by environmental conditions in a manner recommended by material manufacturer.

Protection

Provide adequate protection of materials and work of this trade from damage by weather, traffic and other causes.

Part 2 – Products

Materials

Insulation – PlastiSpan insulation board conforming to CAN/ULC-S701, Type 1: thicknesses as shown on the drawings (or specify) (See Notes 3 & 4) PlastiSpan HD insulation board conforming to CAN/ULC-S701, Type 2; thicknesses as shown on the drawings (or specify). (See Notes 3 & 4)

Primers – (See Note 5)

Adhesives – Roofing asphalt, conforming to the requirements of CSA A123.3 M1979, Type 2.

Fasteners

Nails – Galvanized Box Nails or Galvanized Common Nails with 25 mm (1") prepunched fibre washers.

U-Drive Fasteners – by U-Can Fastening Products (See Note 7)

Wood Skewers – 6 mm (1/4") Hardwood Skewers treated with wood preservative. (See Note 8)

Vapour Barriers

Trowel-On – (See Note 9)

Film – 6 mil polyethylene

Juncture Flashing – Heavy duty flexible moisture/vapour barrier

Slip Sheet – #15 Asphalt Felt

Part 3 – Execution

Inspection

Check that:

1. Concrete surfaces are level, straight and clean and that fins or projections left after stripping of concrete forms have been removed.
2. Masonry surfaces are plumb level, straight and clean with mortar joints struck flush with masonry
3. Portland cement plaster has been applied where necessary to straighten surfaces.
4. Framed walls and ceilings are straight and true.

Application

Workmanship shall be to the best standard practice for this type of work and shall be done in accordance with instructions contained in the applicable Plasti-Fab brochures:

Cold Storage Applications

Roof Insulation:

- Selection, Application and Specification
- Built Up Roofing
- Fire Rated Roof Assemblies
- Single Ply Roofing
- Sloped Roof Insulation
- Standing Seam Roofing

Insulation will be installed in thicknesses and number of layers as shown on the drawing.

Specifications Continued

Butt insulation boards together, tight without gaps, stagger end joints keep joints free of adhesive.

Offset joints in succeeding layers from preceding layer.

Fit boards around pipes, ducts, openings, corners, obstructions, etc to provide a

continuous insulation covering. Seal around openings and where there are discontinuities to ensure the air seal for the construction is maintained.

Finish (See Note 10)

Roofing (See Note 11)

Clean Up

Promptly as the work proceeds and on completion, clean up and remove from the site all debris and surplus materials resulting from the work of this trade.

Specification Notes

1. This specification is basic and must be adapted to suit the requirements of individual projects. It is written in accordance with the Construct/on Specifications Canada three-part section format and should be included as a separate section under DIVISION 13 SPECIAL CONSTRUCTION.
2. Insert list of other Divisions or other sections of this division where related or allied work is specified.
3. Determine insulation thickness based upon the expected service temperature range. Protect work of other trades from damage resulting from work of this trade. Make good such damage at own expense to satisfaction of owner's representative.
4. Primer must be compatible with the adhesive or vapour barrier coating to be used.
5. Adhesive used in contact with PlastiSpan insulation board must be recommended by the adhesive manufacturer as suitable for use with expanded polystyrene insulation
6. Choose length of U-Drive fastener to allow minimum 25 mm (1") to penetration into masonry or concrete.
7. Length of wood skewers to be sufficient to penetrate the total thickness of the insulation to be fastened when driven at an angle of 30°.
8. Vapour barriers to have vapour barrier rating to achieve the requirements of the design. Any solvent based coatings or adhesives must be thoroughly cured before the PlastiSpan insulation board is placed in contact with them
9. Specify finish under the appropriate sections of Division 9 - Finishes.
10. Specify roofing under the appropriate sections of Division 7- Thermal Resistance Protection.